

iA H.265 360-degree Vandal Resistant Outdoor Dome Camera

Panasonic WV-S4550L / WV-S4550LM captures the highest quality images in even very challenging and dynamic environments. In particular, the image of the person's face or object at the edge of the fisheye is clear with less distortion.

Intelligent Auto (iA) monitors scene dynamics and motion to adjust key camera settings automatically in real-time reducing distortion such as motion blur on moving objects. Adopting H.265 Smart Coding technology, bandwidth efficiency is intelligently increased for longer recording and less storage. Out of the box, the camera supports full data encryption streaming and is compliant to FIPS 140-2 Level 1 standards to keep your video secured. *Value in Advanced mode. It depends on the scene.

Extreme image quality for evidence capturing under challenging conditions

- Clear and less distorted image of the person's face and objects at the edge of the fisheye
- Instant response to sudden light changes like tunnel entry and exit
- Auto Shutter speed control for fast moving objects
- Super Dynamic 108dB for backlit situations and shadows on night streets
- Built-in IR LED to produce a clear monochrome image in zero lux conditions with 10 m (33 feet) irradiation distance
- Environmental durability : EN50155, IP66, IK10, 50J compliant and Dehumidification device

Extreme H.265 compression with new Smart Coding

- Longer recording and less storage space compared to any H.264 based compression techniques
- New self-learning ROI* encoding (Auto VIQS) dynamically detects motion areas to keep vehicles and humans in good picture quality while lowering your bandwidth * Region of Interest

Extreme Data Security

- Full encryption SD card edge recording to keep your data safe
- FIPS 140-2 Level 1 compliant
- Full end-to-end system encryption with supported VMS and devices to protect from IP snooping/spoofing and detect data alteration

Complete with powerful analytics built-in*

- Heat map : Visualization of people's traffic pattern and staying times
- People Counting : Statistics data on the number of people entering and leaving a specific zone
- MOR (Moving Object Remover) : Monitoring of only the surrounding environment by removing people and other moving objects from video *To enable analytics, please add the optional WV-SAE200 software.

Key Features

- 5 Megapixel images up to 30 fps
- iA (intelligent Auto)
- Super Dynamic 108dB
- H.265 Smart Coding
- IP66, IK10, 50J compliant, Dehumidification device

Applications

- Retail / Bank
- Education / Hospital
- Building
- Transportation (Airport / Train, Subway station)
- Logistics



Specifications

Camera	Image Sensor	Approx. 1/3 type MOS image sensor
	Minimum Illumination	Color : 0.3 lx, BW : 0.04 lx (F2.4, Maximum shutter : Off (1/30 s), AGC : 11) BW : 0 lx (F2.4, Maximum shutter : Off (1/30 s), AGC : 11, when the IR LED is lit) Color : 0.02 lx, BW : 0.0025 lx (F2.4, Maximum shutter : Max. 16/30s, AGC : 11) *1
	Intelligent Auto	On / Off
	Maximum shutter	Max.16/30s to Max. 1/10000s
	Super Dynamic	On / Off, the level can be set in the range of 0 to 31.
	Dynamic Range	108 dB (Super Dynamic : On, level : 31)
	Image Settings	Gain (AGC), White balance
	Image Compensation	Adaptive black stretch, Back light compensation (BLC), Fog compensation, High light compensation (HLC), Digital noise reduction
	Color/BW (ICR)	Off / On (IR Light Off) / On (IR Light On) / Auto1 (IR Light Off) / Auto2 (IR Light On) / Auto3 (SCC)
	IR LED	High* / Middle / Low / Off *Maximum irradiation distance : 10 m (Approx. 33 ft) (Peripheral intensity control : On)
	Video Motion Detection (VMD)	On / Off, 4 areas available
	Intelligent VMD (i-VMD) ²	Type 5 *optional plug-in software WV-SAE200
	Privacy Zone	On / Off (up to 8 zones available)
	Camera Title (OSD)	On / Off Up to 20 characters (alphanumeric characters, marks)
Fixing angle adjustment	-5°, 0°, +5°	
Lens	Zoom Ratio	1x
	Digital (electronic) zoom	Choose from 3 levels of x1, x2, x4
	Focal length	0.84 mm (1/32 inches)
	Maximum Aperture Ratio	1 : 2.4
	Focus range	0.3 m (11-13/16 inches) - ∞
Angular Field of view	Horizontal : 186° Vertical : 186°	
Browser GUI	Camera Control	Brightness, AUX On / Off
	Audio	Mic (Line) Input : On / Off Volume adjustment : Low / Middle / High Audio Output : On / Off Volume adjustment : Low / Middle / High
Network	GUI / Setup Menu Language	English, Italian, French, German, Spanish, Portuguese, Russian, Chinese, Japanese
	Network IF	WV-S4550L : 10Base-T / 100Base-TX, RJ45 connector WV-S4550LM : 10Base-T / 100Base-TX, M12 connector
	Resolution <Ceiling>	• Fisheye mode max.30 fps 2192×2192 / 1280×1280 / 640×640 / 320×320
	<Wall>	• Quad PTZ mode max.30 fps, Single PTZ mode max.30 fps 1600×1200 / 1280×960 / 800×600 / VGA / QVGA
	<Ceiling>	• Double Panorama mode (max. 30 fps) 1920×1080 / 1280×720 / 640×360 / 320×180 • Fisheye + Double Panorama mode (max. 30 fps) (Fisheye) 2192×2192 / 1280×1280 / 640×640 / 320×320 (Double Panorama) 1280×720 / 640×360 / 320×180 • Fisheye + Quad PTZ mode (max. 30 fps) (Fisheye) 2192×2192 / 1280×1280 / 640×640 / 320×320 (Quad PTZ) 1280×960 / 800×600 / VGA / QVGA • Quad streams mode (Single PTZ (Quad streams)) 1280×960 / 800×600 / VGA / QVGA (max. 30 fps) (Quad PTZ) 1600×1200 / 1280×960 / 800×600 / VGA / QVGA (max. 5 fps)
	<Wall>	• Panorama mode (max. 30 fps) 1920×1080 / 1280×720 / 640×360 / 320×180 • Fisheye + Panorama mode (max. 30 fps) (Fisheye) 2192×2192 / 1280×1280 / 640×640 / 320×320 (Panorama) 1280×720 / 640×360 / 320×180

*1 Converted value
*2 Auto VIQS, i-VMD, can not be used at the same time.
*3 Transmission for 2 streams can be individually set.

Network	H.265/ H.264 ³	Transmission Mode	Constant bit rate / VBR / Frame rate / Best effort
	JPEG	Transmission Type	Unicast / Multicast
	Smart Coding	Image Quality	10 steps
	Audio Compression	GOP (Group of pictures) control :	On (Frame rate control) / On (Advanced)* / On (Low) / On (Mid) / Off *On (Frame rate control) and On (Advanced) are only available with H.265. Auto VIQS : On / Off
	Supported Protocol	G.726 (ADPCM) : 16 kbps / 32 kbps, G.711 : 64 kbps, AAC-LC ⁴ : 64 kbps / 96 kbps / 128 kbps	
	Maximum concurrent access number	IPV6 : TCP/IP, UDP/IP, HTTP, HTTPS, FTP, SMTP, DNS, NTP, SNMP, DHCPv6, RTP, MLD, ICMP, ARP, IEEE 802.1X, DiffServ IPV4 : TCP/IP, UDP/IP, HTTP, HTTPS, RTSP, RTP, RTP/RTCP, FTP, SMTP, DHCP, DNS, DDNS, NTP, SNMP, UPnP, IGMP, ICMP, ARP, IEEE 802.1X, DiffServ	
	SDXC/SDHC/SD	Up to 14 users (Depends on network conditions)	
	Memory Card (Option)	H.265 / H.264 recording : Manual REC / Alarm REC (Pre/Post) / Schedule REC / Backup upon network failure JPEG recording : Manual REC / Alarm REC (Pre/Post) / Backup upon network failure Compatible SDXC/SDHC/SD card : Panasonic 2 GB, 4 GB*, 8 GB*, 16 GB*, 32 GB*, 64 GB**, 128 GB**, 256 GB**model *SDHC card, ** SDXC card (except miniSD card and microSD card)	
	Mobile Terminal Compatibility	iPad, iPhone (iOS 4.2.1 or later), Android™ mobile terminals	
	Alarm	Alarm Source	3 terminals input, VMD, Command alarm
Alarm Actions		SDXC/SDHC/SD memory recording, E-mail notification, HTTP alarm notification Indication on browser, FTP image transfer, Panasonic alarm protocol output	
Input/Output	Audio Input	ø3.5 mm stereo mini jack, Recommended applicable microphone : Plug-in power type (Sensitivity of microphone : -48 dB ±3 dB (0 dB=1 V / Pa, 1 kHz)) Input impedance : Approx. 2 kΩ (unbalanced) Supply voltage : 2.5 V ±0.5 V	
	Audio Output ⁵	ø3.5 mm stereo mini jack (monaural output) Output impedance : Approx. 600 Ω (unbalanced) Output level : -20 dBV	
	External I/O Terminals	ALARM IN 1 (Black & white input, Auto time adjustment) (x1), ALARM IN 2 (ALARM OUT) (x1), ALARM IN 3 (AUX OUT) (x1)	
General	Power Source and Power Consumption	DC power supply : DC12 V 910 mA, Approx. 10.9 W PoE (IEEE802.3af compliant) Device : DC48 V 240 mA, Approx. 11.5 W (Class 0 device)	
	Ambient Operating Temperature	IR LED : On -40 °C to +50 °C (-40 °F to 122 °F) IR LED : Off -40 °C to +60 °C (-40 °F to 140 °F)	
	Ambient Operating Humidity	10% to 100 % (no condensation)	
	Water and Dust Resistance	IP66(IEC60529), Type 4X(UL50), NEMA 4X compliant	
	Shock Resistance	50J (IEC 60068-2-75 compliant), IK10 (IEC 62262)	
	Railway Application	EN50155	
	Dimensions	When using the attachment plate : ø154 mm × 60.3 mm (H) (ø6-1/16 inches × 2-3/8 inches (H)) Dome radius 35 mm (1-3/8 inches) When using the base bracket <WV-S4550L> : ø164 mm × 96.3 mm (H) (ø6-15/32 inches × 3-25/32 inches (H)) Dome radius 35 mm (1-3/8 inches)	
Mass (approx.)	When using the attachment plate : Approx. 870 g (1.92 lbs) When using the base bracket <WV-S4550L> : Approx. 1.3 kg (2.87 lbs)		
Finish	Main body : Aluminum die cast, Light gray Outer fixing screws : Stainless steel Dome section : Polycarbonate resin, Clear		

*4 Only use AAC-LC (Advanced Audio Coding - Low Complexity) when recording audio on an SD memory card.
*5 The audio output can be switched to the monitor output. Refer to the Operating Instructions on the provided CD-ROM for descriptions of how to switch the output. (factory shipment : NTSC monitor)



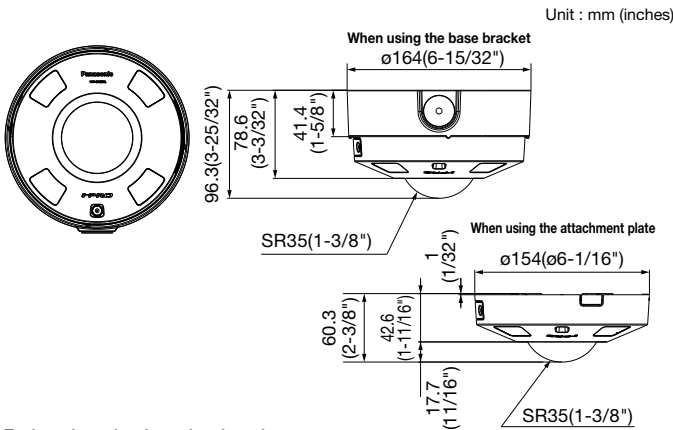

Appearance



Trademarks and registered trademarks

- iPad and iPhone are registered trademarks of Apple Inc.
- Android is a trademark of Google Inc.
- ONVIF and the ONVIF logo are trademarks or registered trademarks of ONVIF Inc.
- All other trademarks identified herein are the property of their respective owners.
- Masses and dimensions are approximate. • Specifications are subject to change without notice.

Optional Accessories

Ceiling Mount Bracket WV-Q121B  (This bracket requires WV-Q186 or WV-Q124.)	Wall Mount Bracket WV-Q185 (Light gray) WV-Q122A (Fine silver)  (This bracket requires WV-Q186 or WV-Q124.)	Mount Bracket WV-Q186 (Light gray) WV-Q124 (Fine silver)  (This bracket requires WV-Q185 or WV-Q122A.)	Pole Mount Bracket WV-Q182 (Light gray) WV-Q188 (Fine silver)  (This bracket requires WV-Q185 or WV-Q122A.)	Corner Mount Bracket WV-Q183 (Light gray) WV-Q189 (Fine silver)  (This bracket requires WV-Q185 or WV-Q122A.)
---	--	--	---	---

Plug-in Software for i-VMD
WV-SAE200

i-VMD is possible to detect objects in the specified area by advanced video analysis technology.
i-VMD : People Counting, Heat-map, MOR (Moving Object Remover), Intruder Detection, Loitering Detection, Cross line Detection, Object Detection, Scene change Detection

Notification sent to the monitoring screen



Important

- Safety Precaution : Carefully read the Important Information, Installation Guide and operating instructions before using this product.
- Panasonic cannot be responsible for the performance of the network and/or other manufacturers' products used on the network.

DISTRIBUTED BY :

Panasonic

<http://security.panasonic.com>

 <http://www.facebook.com/PanasonicNetworkCamera>

(2A-2018A)